

# SAFETY SCREEN DOORS & GRILLS



True Security with a touch of  
*Style & Colour!*



COLONIAL CASTINGS

# STUNNING HINGED DOORS WITH GLASS INSERTS

Glass insert colour options:  
Photos are for illustrative purposes only

TEAL BLUE

OLIVE GREEN

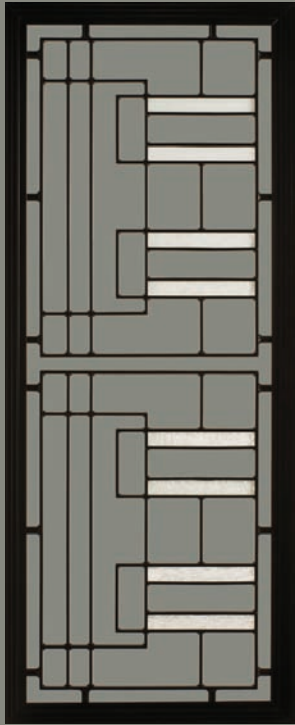

SP65AB RICE PAPER GLASS

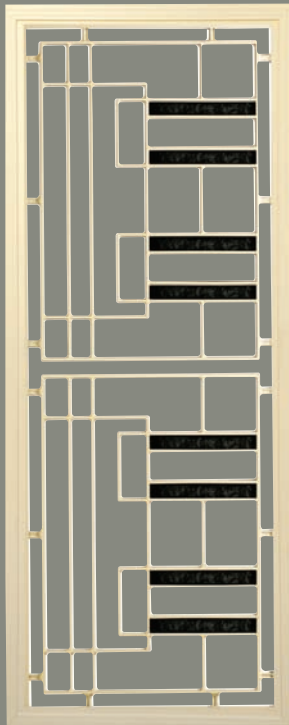

SP65AB BLACK GLASS

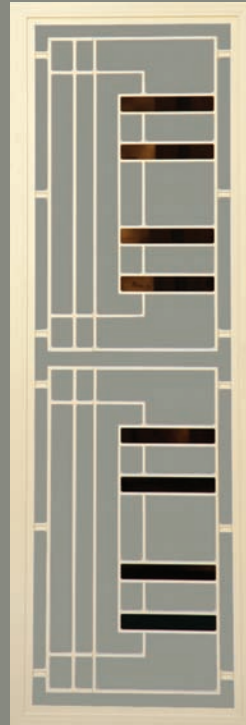

SP69 BLACK GLASS  
Side Light French Door: 2 per door

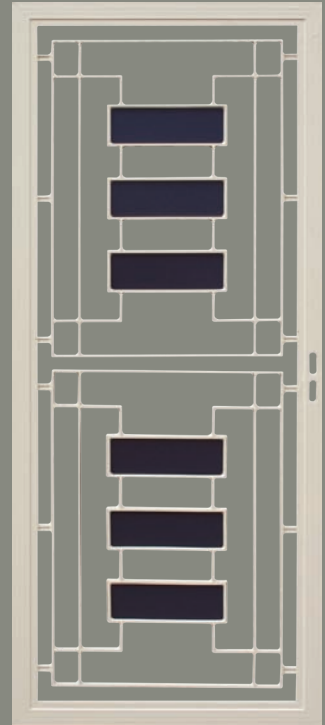

SP77- 2 PER DOOR  
Aluminium inserts can be coated in any colour from our colour range.



SP61AB BLACK ORCHID



SP62AB RED ORCHID



SP61AB ROSE JEWEL

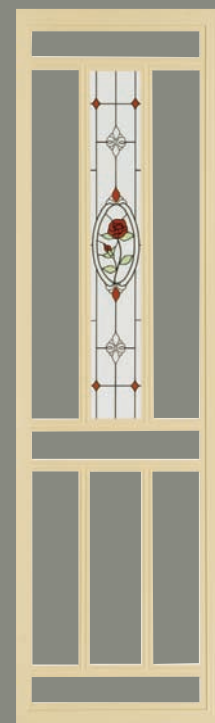

SP68 AB ROSE JEWEL



Kookaburra  
Glass Insert  
available.

These glass panel doors feature elegant decorative designs imposed on glass panels. To clean simply wipe over with a damp cloth, avoid all acid based cleaners.

Side light



# ART DECO RANGE

- CHOICE OF COLOURED DISC INSERTS**
- Bright Red
  - Bistro Orange
  - Satin Black
  - French Blue
- \* Colours for illustration purposes only \*

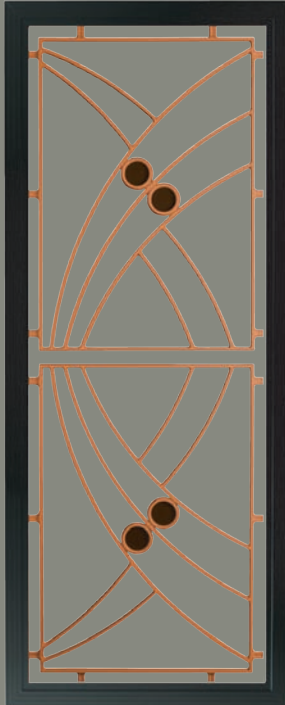

SP71AB ART DECO ORANGE

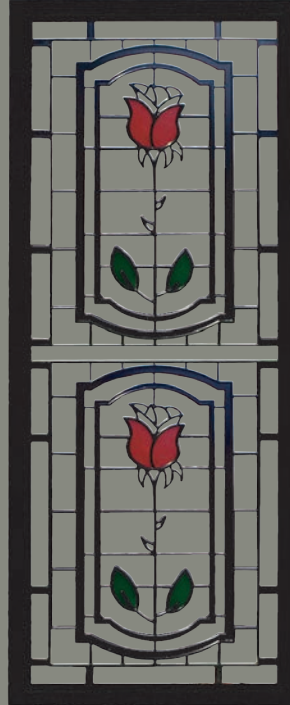

SP75AB

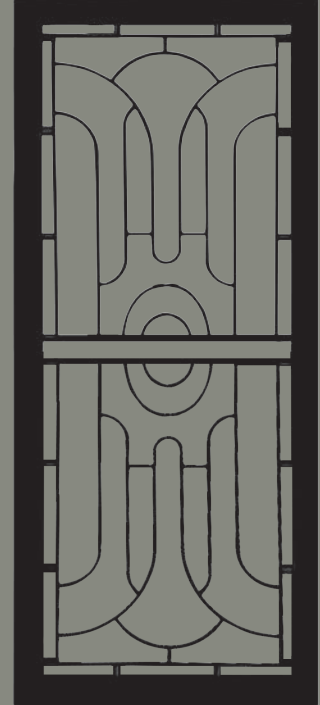

SP79 2 PER DOOR

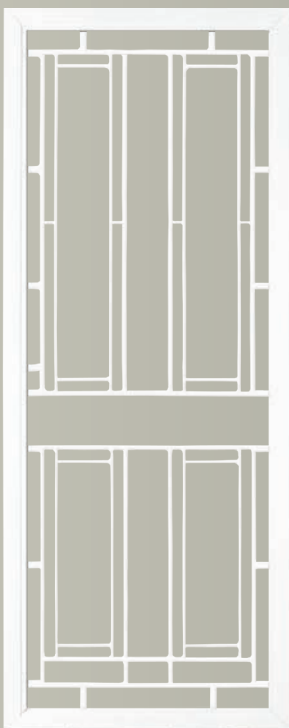

SP34AB

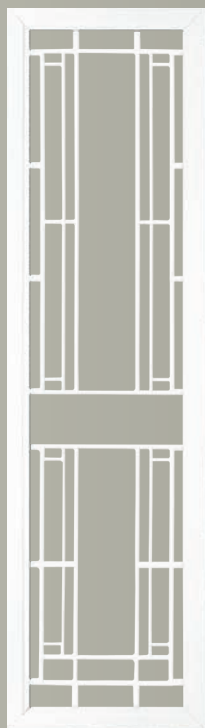

SP35AB



SP14AB



SP18AB



SP78AB

COLONIAL CASTINGS

# STUNNING HINGED DOORS



28M



27M



27M2

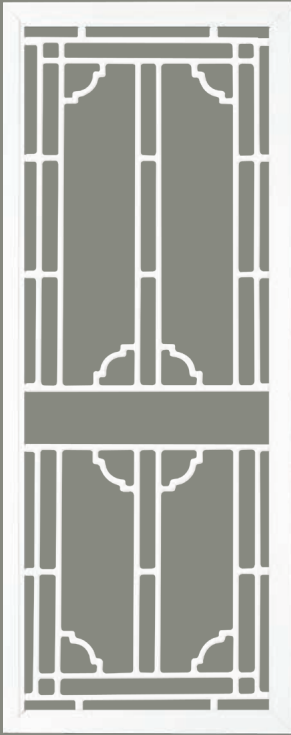

SP27AB



SP28AB

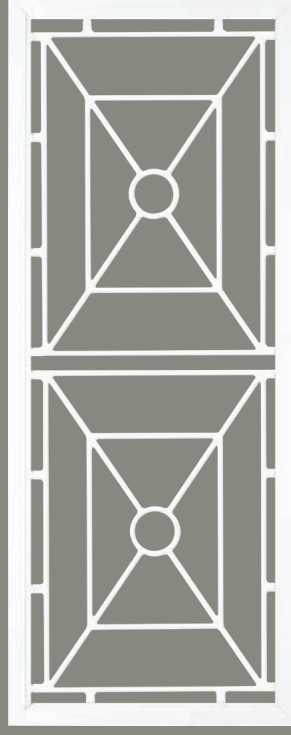

SP30  
2 per door

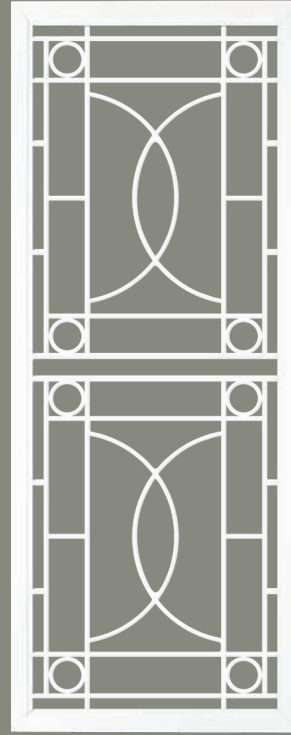

SP17  
2 per door

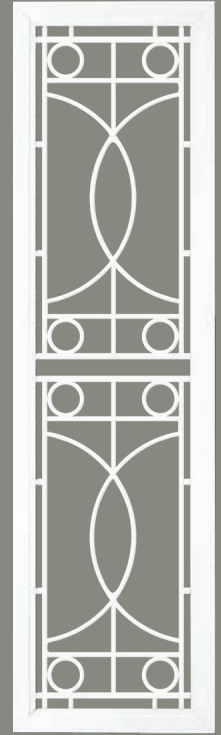

SP36  
2 per door

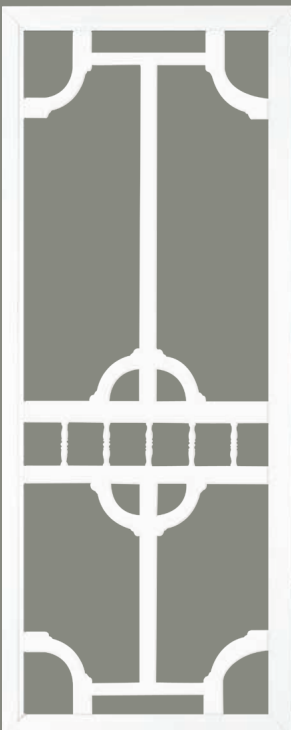

SP37AB



SP52  
2 per door



SP53  
2 per door



SP50AB

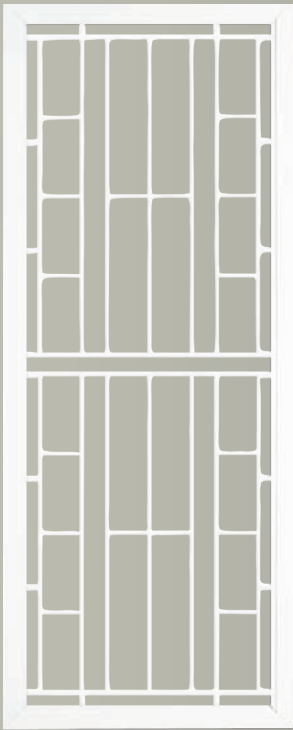

SP13BB  
2 per door

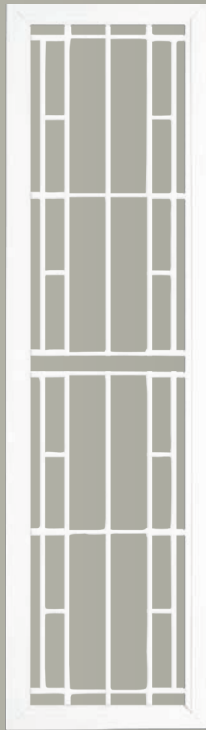

SP16BB  
2 per door

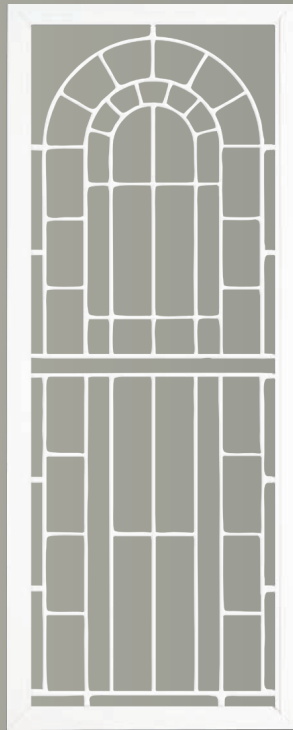

SP13AB

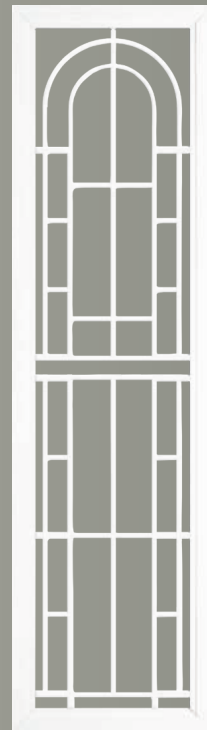

SP16AB

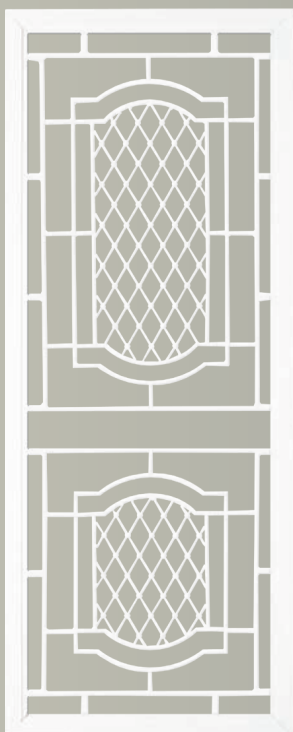

SP44AB

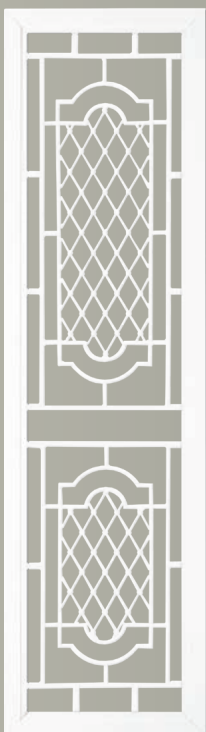

SP45AB

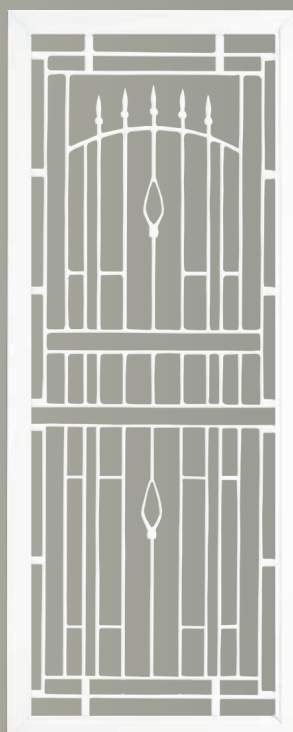

SP29AB

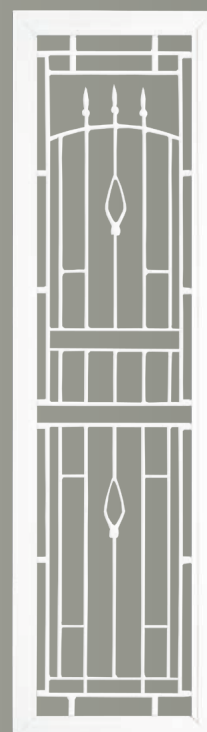

SP31AB

# ELEGANT HINGED DOORS

BY COLONIAL CASTINGS

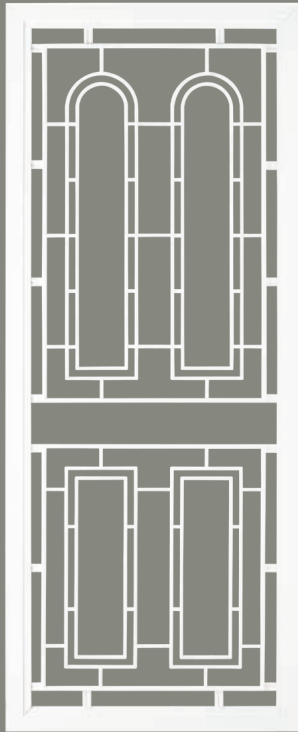

SP51AB

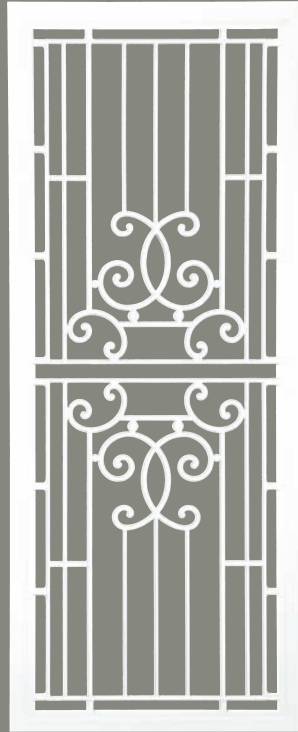

SP56  
2 per door

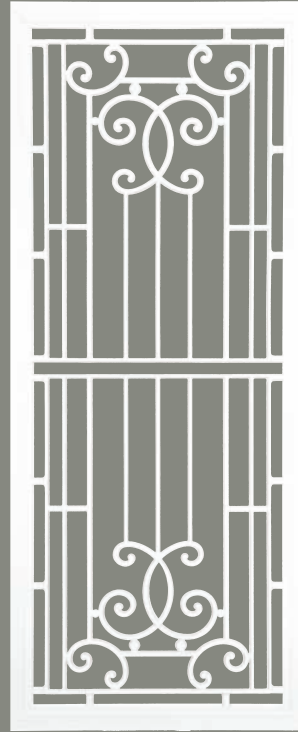

SP55  
2 per door



SP57AB



SP6  
2 per door

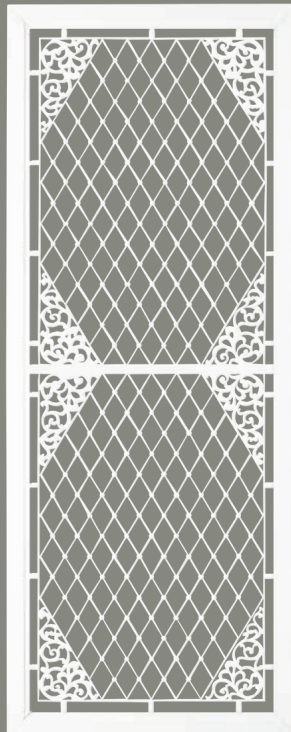

SP10  
2 per door



SP21  
2 per door

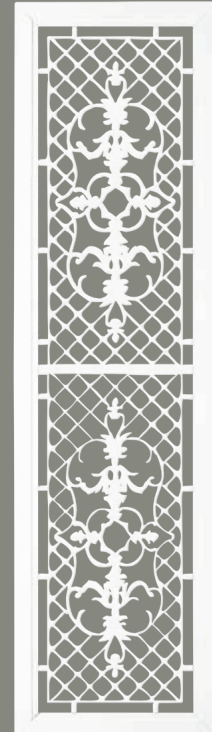

SP22  
2 per door

# SECURITY MESH DOORS

BY COLONIAL CASTINGS

## GALVANISED MESH



### GALVANISED MESH SP70

Woven Galvanised Mesh:

**Features:**

- Small holes
- Powder coated black galvanised mesh
- Spacer available for ease of fixing using pop rivets
- Suits hinge and sliding doors windows and screens

Passed Impact Test AS5041-2003  
 Passed Lock and Hinge Test AS5041-2003  
 Passed Australian Sheer Test AS5041  
 Powder coated black

**Standard sizes:** 2.0mm thick  
 750 x 2400mm      750 x 2000mm  
 900 x 2400mm      900 x 2000mm  
 1200 x 2400mm      1200 x 2000mm

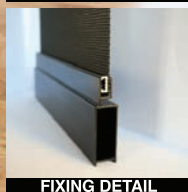
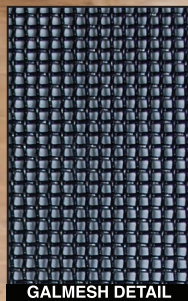

## 2MM PUNCHED ALUMESH



### ALUMESH SP67

2mm Punched Aluminium

**Features:**

- Small holes
- Powder coated black galvanised mesh
- Spacer available for ease of fixing using pop rivets
- Suits hinge and sliding doors windows and screens

Passed Impact Test AS5041-2003  
 Passed Lock and Hinge Test AS5041-2003  
 Passed Australian Sheer Test AS5041  
 Powder coated black

**Standard sizes:** 2.0mm thick  
 750 x 2400mm      750 x 2000mm  
 900 x 2400mm      900 x 2000mm  
 1200 x 2400mm      1200 x 2000mm



## ADD A TOUCH OF CLASS TO YOUR ENTRANCE... SAFETY AND SECURITY DOORS

The strength and security of 2mm Punched Aluminium mesh in combination with aluminium decorative panel attached, gives you safety and a very attractive appearance for your main entry.

Our decorative cast panels are available in our full range of colours to choose from.

Aluminium punched mesh is also available in 2 colours: BLACK OR GULL GREY.

The cast panels are chemically attached to the aluminium mesh then riveted on the back with stainless steel rivets.



ALUMESH DETAIL



FIXING DETAIL

### BLACK MESH SP74

Passed Impact Test AS5041-2003  
Passed Lock and Hinge Test AS5041-2003  
Passed Australian Sheer Test AS5041  
Powder coated black or Gull Grey

**Standard sizes:** 2.0mm thick  
750 x 2000mm  
900 x 2000mm  
1200 x 2000mm

Larger sizes available on application.



ALUMESH DETAIL



FIXING DETAIL

### GULL GREY MESH SP81

Passed Impact Test AS5041-2003  
Passed Lock and Hinge Test AS5041-2003  
Passed Australian Sheer Test AS5041  
Powder coated black or Gull Grey

**Standard sizes:**  
750 x 2000mm  
900 x 2000mm  
1200 x 2000mm

Larger sizes available on application.



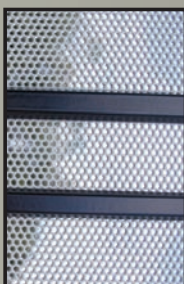

### GULL GREY MESH SP74

Passed Impact Test AS5041-2003  
 Passed Lock and Hinge Test AS5041-2003  
 Passed Australian Sheer Test AS5041  
 Powder coated black or Gull Grey

**Standard sizes:**  
 750 x 2000mm  
 900 x 2000mm  
 1200 x 2000mm

Larger sizes available on application.

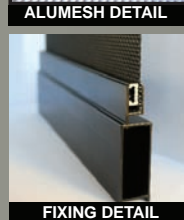

### GULL GREY MESH SP72

Passed Impact Test AS5041-2003  
 Passed Lock and Hinge Test AS5041-2003  
 Passed Australian Sheer Test AS5041  
 Powder coated black or Gull Grey

**Standard sizes:**  
 750 x 2000mm  
 900 x 2000mm  
 1200 x 2000mm

Larger sizes available on application.

# CC2075

# HINGED BARRIER DOOR LOCK

The CC2075 hinged barrier door lock is made from a zinc die cast body with stainless steel strikes providing the highest level of protection for hinged screen doors.

## FEATURES

- Contemporary styled furniture
- Non handed furniture - suits left handed and right handed doors
- 3 point kits for additional security available
- Fits industry standard cut outs
- Zinc diecast lock mechanism and furniture
- Mortice lock inside snib
- Accepts Euro profile lazy cam cylinder
- Suit standard 20mm door thickness
- Tested & exceeds Australian & New Zealand AS4145 standard

### How to order CC2075 Barrier Hinged Door Furniture

CC2075 / SB  
⋮            ⋮  
Furniture    Finish

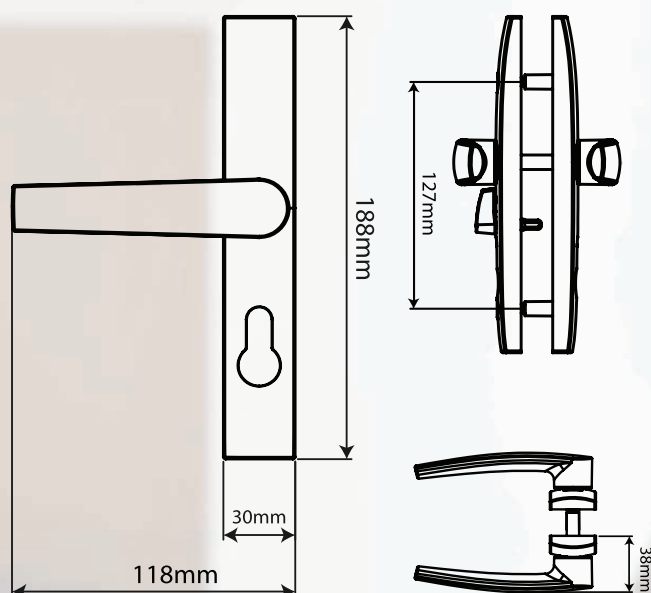

### TECHNICAL SPECIFICATIONS

Materials:	Zinc Diecast
Finishes Available:	Black, White, Primrose
Keying:	Euro profile lazy camcylinder locks CC186, CC198

COLONIAL CASTINGS

# SLIDING DOORS

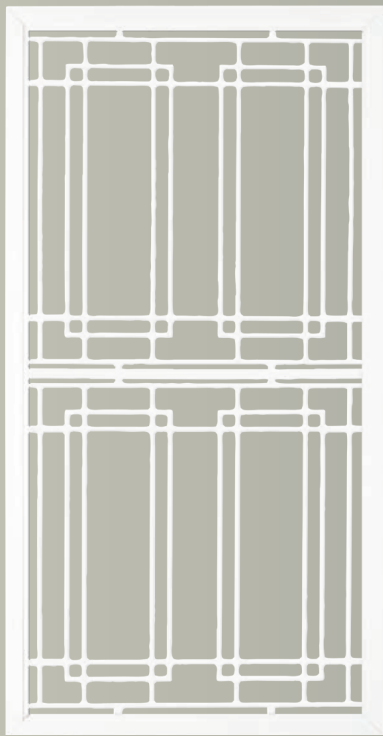

SP48S\* 2 per door



SP14S\*/SP15B\*

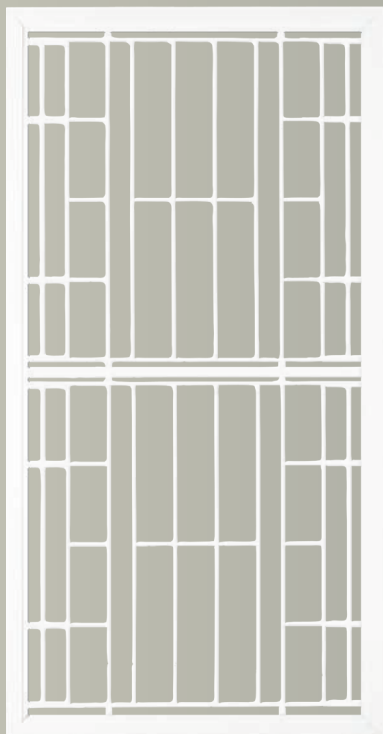

SP15BB\* 2 per door

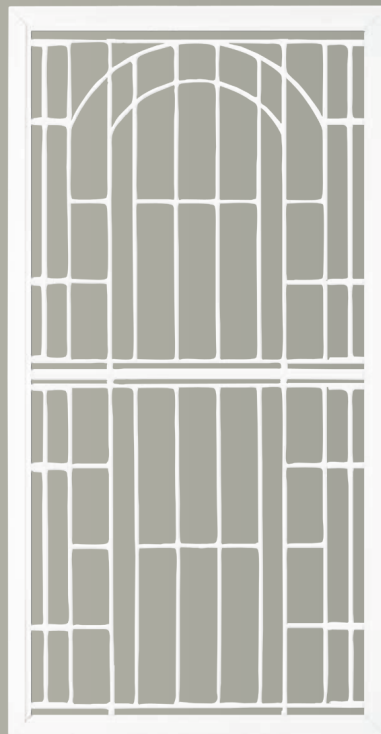

SP15AB\*

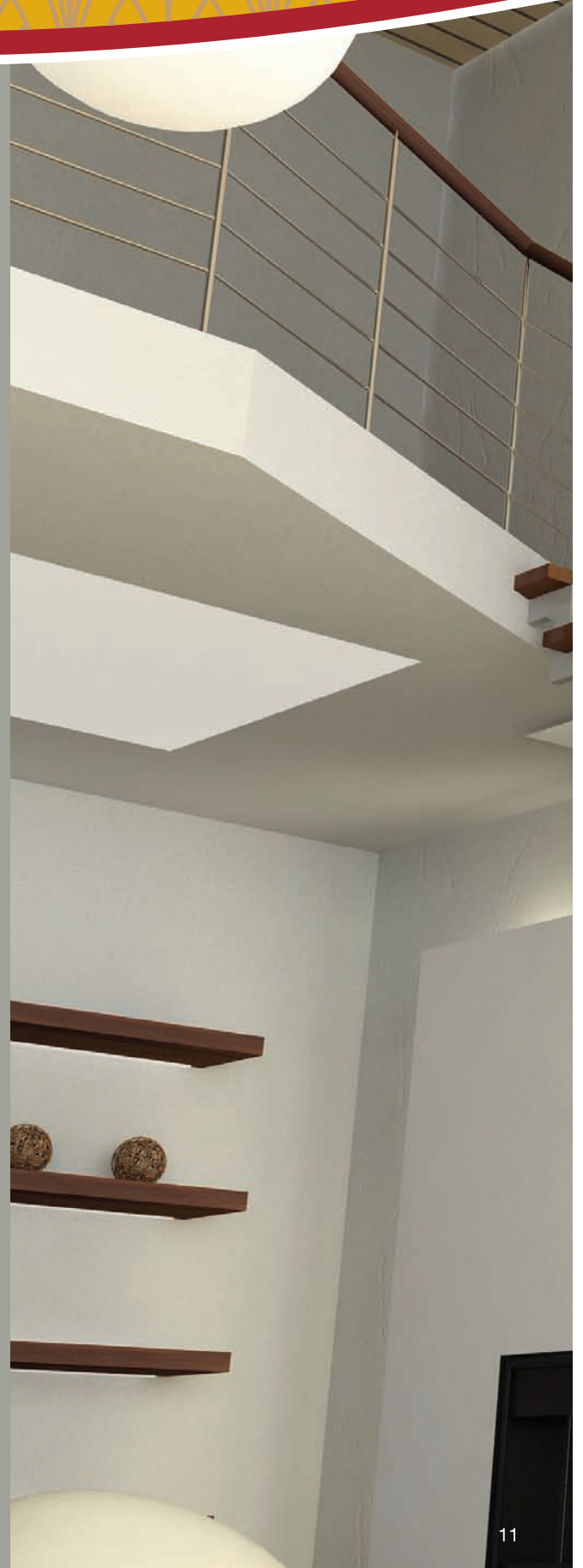



### **FINISHED COLOUR OPTIONS:**

Primrose  
White  
Black (Night Sky)  
APO Grey  
Bronze  
Brown  
Mist Green (Pale Eucalypt)  
Heritage Green  
Hawthorn Green  
Mountain Blue (Deep Ocean)  
Claret  
Magnolia  
Stone Beige  
Pottery  
Birch White  
Paper Bark (Marino)  
Notre Dame  
Slate Grey (Woodland Grey)

### **COLOURS ON REQUEST:**

Charcoal  
Anotec Dark Grey  
Silver  
Dune  
Surf Mist

Established in 1947 Colonial Castings is an Australian owned company that has been making quality safety screen panels to suit safety doors for over 20 years. Rust will never be a problem; all door inserts are gravity die cast in 100% recyclable aluminium, which is also known for its durability and strength. The frames are constructed from exhausted aluminium.

To capture that added touch of personal style and individuality, we offer you a wide choice of colours in a hardy powder coated finish. Naturally the powdering is covered by a 24 month guarantee. To extend the life of the surface we recommend doors should be washed down regularly especially in salt water environments.

95 - 97 Market Street  
Smithfield 2164  
T. 02 9604 8222  
F. 02 9604 3064

[www.colonialcastings.com.au](http://www.colonialcastings.com.au)  
[info@colonialcastings.com.au](mailto:info@colonialcastings.com.au)